

REFERENCE GUIDE SUPPLEMENT

GROTE VEHICLE LIGHTING SYSTEMS

VEHICULE GROTE SYSTÈMES D'ÉCLAIRAGE

VEHÍCULO GROTE SISTEMAS DE ILUMINACIÓN



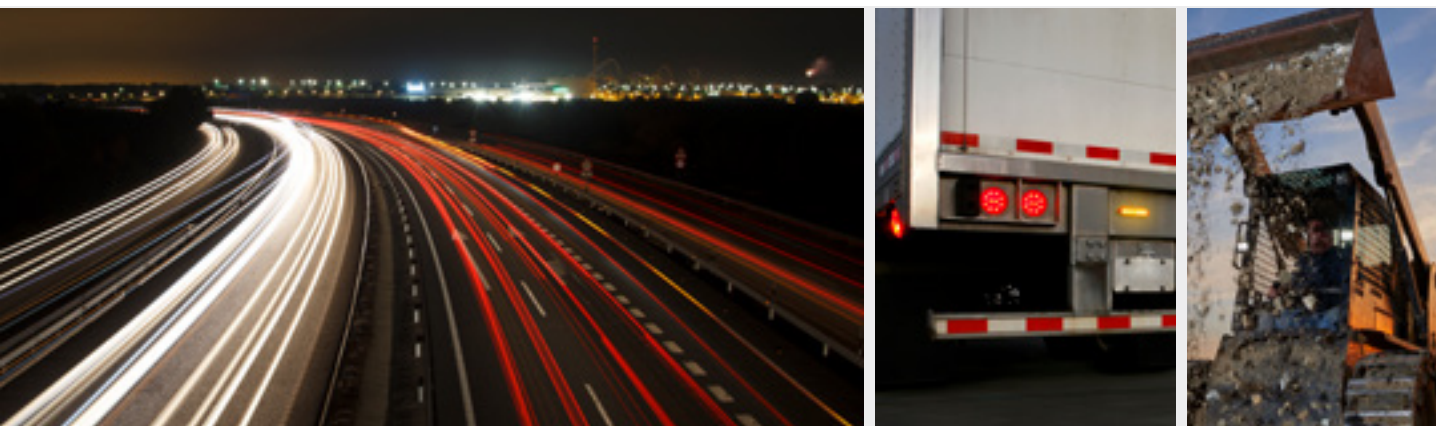

ABOUT THIS GUIDE

Use the New Product Supplement alongside our Reference Guide to quickly find parts or confirm specs, or head over to Grote.com, where the latest information on new products is always available.

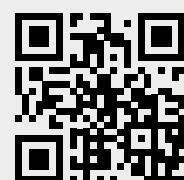

GROTE.COM

If you're looking for the latest information about Grote products, be sure to check out our website, Grote.com. Instantly access our full product catalog, competitive interchanges, distributor locator, live helpdesk, and a wide range of Grote resources. The search function allows users to filter products by size, shape, voltage, content, and brand, among others. Help your customers find the parts they need, when they need them, with Grote.com.

CONTENTS

- 01 WORK LIGHTING**
 - 04 BriteZone™ LED Work Lamps
 - 06 Trilliant® LED Work Lamps
 - 08 E90 LED Halogen Replacement
- 02 INTERIOR LIGHTING**
 - 09 Dome Lights & Switches
- 03 FORWARD LIGHTING**
 - 10 LED Headlamps/Headlights
 - 10 LED Off-road Light Bars
 - 11 Adapters and Harnesses
- 04 WARNING & HAZARD**
 - 12 LED Auxiliary Strobe & Stop Lamps
 - 12 LED Traffic Director/Stick Accessories
 - 13 Compact LED Beacons
 - 13 LED Warning Lights
 - 13 HINVII: Safety with Intelligent Illumination
 - 14 LED Magnetic Warning Lights
 - 14 360° Portable LED Warning Light
 - 14 Triangle Warning Kit
 - 15 Mighty Mini Strobe Light
 - 15 Backup Alarm
 - 15 Beacon Replacement Lenses
 - 15 Brackets & Accessories
 - 15 LED Traffic Directors/Controllers
- 05 SIGNAL LIGHTING**
 - 16 LED Clearance/Marker Lights
 - 17 LED Magnetic Towing Kit
 - 17 LED Trailer Hitch Cover
 - 17 LED Trailer Kit Lights
 - 18 LED Stop Tail Turn Lights
 - 19 LED Replacement Bulbs
- 06 POWER DELIVERY**
 - 19 Nose Box Cover
 - 19 Connectors & Harnesses

WE KNOW THE POWER OF A GOOD CONNECTION

Connecting you with your customers through digital tools and innovative solutions...



LATEST PRODUCTS

Quickly catch up on everything new from Grote Industries on our New Products page on Grote.com. Featuring all the latest Grote products in an easy-to-use, downloadable format, Grote's New Products page is the fastest way to find all the newest offerings from Grote Industries.

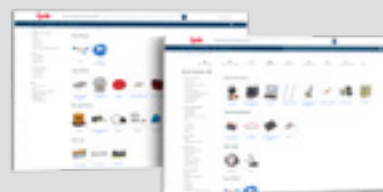

GROTE G24/7

Our newly updated G24/7 online ordering system is now quicker, more convenient, and easier to use. Browsing products, placing and tracking orders, and checking current inventory and lead times are now easier than ever. Pay any invoice online at any time with our fast, easy, mobile-friendly credit card processing. G24/7 is your one-stop shop for ordering Grote products.

GROTE BRITEZONE™ LED WORK LAMPS



SAFETY ON THE WORKSITE IS ABOUT VISIBILITY AND PROPERLY ILLUMINATING BOTH THE WORK ZONE AND YOUR CREW

SEE AND BE SEEN WITH GROTE BRITEZONE LED WORKLAMPS, THE PERFECT SOLUTION FOR LIGHT WHERE YOU NEED IT, WHEN YOU NEED IT

Grote's line of affordable LED lamps are designed to work when you need them—no excuses. Rain or shine, day or night, wet or dry—Grote's signature design, quality, and performance are on display. With rugged, durable construction and LED power that far outshines halogen, BriteZone™ lamps get the job done.

Boating. Mowing. Off-roading. Working. Long after the sun goes down, you're still out there doing your thing—and you need a lamp that's as tough and tireless as you are. Grote's BriteZone™ range has the LED lamp to shed light on any use—even tow trucks, garbage trucks, and forklifts—without breaking the bank.



HANDHELD BRITEZONE™ LED WORK LAMPS



PART #	DESCRIPTION	BEAM	LUMENS	VOLTAGE
BZ421-5	BriteZone Magnetic LED Work Lamp	Flood	2,160 (RAW)	12 VDC
BZ501-5	BriteZone Go Anywhere Hand Held LED Work Lamp	Flood	1,100 (RAW)	12 VDC
BZ431-5	BriteZone 360° LED Pocket Light	Spot/Flood	600/250 (RAW)	12 VDC
BZ531-5	BriteZone Twinbeam LED Pocket Light	Spot/Flood	700/250 (RAW)	12 VDC

BRITEZONE™ LED WORK LAMPS



- With rugged, durable construction and LED power that far outshines halogen, BriteZone® lamps get the job done
- Long after the sun goes down, whether you're boating, mowing, off-roading, or working, you need lamps as tough and tireless as you are
- Grote's BriteZone® range has the LED lamp to shed light on any use—even tow trucks, garbage trucks, and forklifts – without breaking the bank
- Value priced to meet any budget

Material: Polycarbonate, Die-Cast Aluminum, Stainless Steel



PART #	DESCRIPTION	BEAM	CONNECTION	LUMENS	AMPERAGE	VOLTAGE
BZ101-5	Round LED Work Lamp	Flood	Blunt Cut	1,600 (RAW)	1.1A @ 13.5VDC, 0.5A @ 28VDC	9-32 VDC
BZ111-5	Round LED Work Lamp	Flood	Blunt Cut	1,240 (RAW)	0.5A @ 28VDC, 1A @ 13.5VDC	12-36 VDC
BZ121-5	Round LED Work Lamp with Switch	Flood	Blunt Cut	1,900 (RAW)	2.0A @ 12VDC	10-32 VDC
BZ131-5	Round LED Work Lamp with Switch	Flood	Deutsch	4,000 (RAW)	2.25A @ 12VDC, 1.12A @ 24V	9-30 VDC
BZ141-5	Small Round LED Work Lamp	Flood	Blunt Cut	1,750 (RAW)	1.5A @ 12VDC	10-30 VDC
BZ201-5	Square LED Work Lamp	Flood	Blunt Cut	1,100 (RAW)	0.5A @ 28VDC, 1A @ 13.5VDC	9-32 VDC
BZ211-5	Small Square LED Work Lamp	Spot	Blunt Cut	1,100 (RAW)	1.0A @ 12VDC	10-30 VDC
BZ221-5	Small Cube LED Work Lamp	Spot	Deutsch	4,800 (RAW)	3.71A @ 12VDC	10-30 VDC
BZ231-5	Square LED Work Lamp	Spot	Deutsch	3,080 (RAW)	3.25A @ 12VDC, 1.625A @ 24VDC	12-24 VDC
BZ301-5	Slim LED Work Lamp	Flood	Blunt Cut	1,400 (RAW)	1.1A @ 13.5VDC, 0.5A @ 28VDC	9-32 VDC
BZ321-5	Recessed LED Work Lamp	Flood	Deutsch	3,600 (RAW)	2.13A @ 12VDC	10-30 VDC
BZ331-5	Small Rectangle LED Work Lamp	Flood	Blunt Cut	860 (RAW)	0.75A @ 12VDC	10-30 VDC
BZ551-5	Square LED Work Lamp	Flood	Blunt Cut	1,200 (RAW)	1.2A @ 13.15VDC, 0.6A @ 28VDC	12-36 VDC
BZ601-5	Mini Square LED Work Lamp	Flood	Blunt Cut	775 (RAW)	0.6A @ 13.5VDC, 0.3A @ 28VDC	12-36 VDC

TRILLIANT® CUBE LED WORK LAMPS



- Compact 4"x4" lamps available in 1,200-lumen model
- Highest quality electronic components and advanced Grote circuit design provides electronically quiet operation. This ensures long life, consistent light output, and protection from voltage spikes and electromagnetic interference
- All-weather design means consistent, reliable light for the task regardless of conditions
- Rugged SAE J575E™-compliant construction protects against vibration, corrosion, moisture, and dust
- Sophisticated reflector optics limit loss, focus more light where it's needed

Housing Material: Powder-Coated Cast Aluminum

Lens Material: Polycarbonate

Bracket Material: CRS Zinc-Plated

Regulations: ECE R10, Dir. 72/245/EEC, Amended by 2006/28/EC

VMRS: 034-006-031

Trilliant®

PART #	DESCRIPTION	BEAM	CONNECTION	LUMENS	VOLTAGE	AMPERAGE
63E21	4"x4" Trilliant® Cube	Flood	Deutsch®	1,200	12/24V	.7A-1.4A
63Y61	4"x4" Trilliant® Cube	Near Flood	Deutsch®	1,200	9-32V	.75A @ 28VDC, 1.5A @ 14VDC
63Y81	4"x4" Trilliant® Cube	Near Flood	Deutsch®	1,200	12V	1.9A @ 14VDC
63Y71	4"x4" Trilliant® Cube	Flood	Deutsch®	1,200	12V	1.9A @ 14VDC
63K41	4"x4" Trilliant® Cube	Flood	Deutsch®	3,000	28V	1.5A

TRILLIANT® OVAL LED WORK LAMPS



- Heavy-duty materials enhance endurance in tough environmental conditions
- Sealed lamp resists particle and water intrusion, meets IP69K
- Innovative thermal management for long product lifetime
- Protected against automotive transients
- LEDs produce white light, reducing eye fatigue and operator stress
- Quality components and advanced Grote circuit design provides quiet operation, consistent light output, protection from voltage spikes/electromagnetic interference
- Sophisticated reflector optics put more light on the task
- Premium-level EMC behavior (CISPR 25 class 5); won't interfere with radio signals
- Complies with ISO 14982 and EN 13309 for operation in agricultural and construction site machinery

Housing Material: Powder-Coated Cast Aluminum

Lens Material: Polycarbonate

Regulations: ECE R10, CE, ISO 14982, ISO 7637-2 / ISO 16750-2, ISO 10605, ISO 20653

Operating Temperature: -40°F to 122°F (-40°C to +50°C)

Trilliant®

PART #	DESCRIPTION	BEAM	CONNECTION	LUMENS	VOLTAGE
64W01	Trilliant® Oval LED Work Lamp	Long Range	Deutsch® DT	2,000 lm	9-32V
64W11	Trilliant® Oval LED Work Lamp	Close Range	Deutsch® DT	2,000 lm	9-32V
64W21	Trilliant® Oval LED Work Lamp	Long Range	Deutsch® DT	3,000 lm	9-32V
64W31	Trilliant® Oval LED Work Lamp	Close Range	Deutsch® DT	3,000 lm	9-32V
64W41	Trilliant® Oval LED Work Lamp	Long Range	Hard Shell Superseal	2,000 lm	9-32V
64W51	Trilliant® Oval LED Work Lamp	Close Range	Hard Shell Superseal	2,000 lm	9-32V
64W81	Trilliant® Oval LED Work Lamp	Long Range	Hard Shell Superseal	3,000 lm	9-32V
64W91	Trilliant® Oval LED Work Lamp	Close Range	Hard Shell Superseal	3,000 lm	9-32V

TRILLIANT® T26 LED WORK LAMPS



- Small size (3") combined with tough construction allows mounting in places where larger or less rugged lamps cannot fit or survive
- 1,000 effective lumens at 5700K color temperature
- Protected against automotive transients and overvoltages
- Rugged mechanical design ensures consistent performance and long life in the harshest environments
- Advanced circuit design provides electronically quiet operation and protects against EMI without interfering with other electronic devices
- Clean, white light designed to represent true colors, just like daylight

Housing Material: Powder-Coated Cast Aluminum

Lens Material: Polycarbonate

Regulations: ECE R10, Dir. 72/245/EEC, Amended by 2006/28/EC

VMRS: 034-006-031

Trilliant®

PART #	DESCRIPTION	BEAM	CONNECTION	LUMENS	VOLTAGE	AMPERAGE
64F61	Trilliant® T26 LED Work Lamp, 24V, No Pigtail	Far Flood	Deutsch®	1,000 lm	24V	0.88A
64F51	Trilliant® T26 LED Work Lamp, 12V, No Pigtail	Near Flood	Deutsch®	1,000 lm	12V	1.7A
64F41	Trilliant® T26 LED Work Lamp, 12V, No Pigtail	Far Flood	Deutsch®	1,000 lm	12V	1.7A

TRILLIANT® LMX LED WORK LIGHTS



Trilliant® LMX LED Work Lights: Robust, Efficient, Powerful. When you need a bright, dependable light for your toughest jobs, you need Trilliant® LMX. Rugged, versatile, and reliable, Trilliant® LMX can easily deliver all the light that a heavy-duty work site requires. With outputs of 5,000, 6,000, or 7,000 lumens to choose from, these are some of the most powerful lights in Grote's lineup. A color temperature similar to daylight (5700K) means these lights are perfect for night work and will illuminate even the darkest surroundings.

- Sealed lamp meets IP69K, resists particle and water intrusion
- Superior thermal design for a long and maintenance-free product lifetime
- Complies with ISO 14982 and EN 13309 for operation in agricultural and construction site machinery
- Illumination for every working area: these high-output work lamps are available with three different lumen outputs ranging from 5,000 to 7,000 lumens

Housing Material: Powder-Coated Cast Aluminum

Lens Material: Polycarbonate

Regulations: ECE R10, ISO 14982, EN 13309

Operating Temperature: -40°F to +158°F (-40°C to +70°C)

Trilliant®

PART #	DESCRIPTION	BEAM	CONNECTION	LUMENS	VOLTAGE	AMPERAGE	WATTAGE
63Z31	Trilliant® LMX LED Work Lights	Close/Long Hybrid	Deutsch® DT	6,000 lm	9-32V	2.4A (28V), 4.6A (14V)	66W
63Z41	Trilliant® LMX LED Work Lights	Close Range	Deutsch® DT	6,000 lm	9-32V	2.4A (28V), 4.6A (14V)	66W
63Z51	Trilliant® LMX LED Work Lights	Long Range	Deutsch® DT	6,000 lm	9-32V	2.4A (28V), 4.6A (14V)	66W
63Z01	Trilliant® LMX LED Work Lights	Close/Long Hybrid	Deutsch® DT	7,000 lm	9-32V	2.7A (28V), 5.7A (14V)	80W
63Z11	Trilliant® LMX LED Work Lights	Close Range	Deutsch® DT	7,000 lm	9-32V	2.7A (28V), 5.7A (14V)	80W
63Z21	Trilliant® LMX LED Work Lights	Long Range	Deutsch® DT	7,000 lm	9-32V	2.7A (28V), 5.7A (14V)	80W



TRILLIANT®

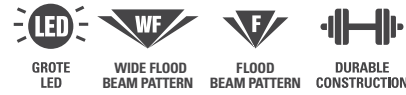

- 4.9" x 9" bi-voltage light available in flood and wide flood

Housing Material: Powder-Coated Black Aluminum
Lens Material: Polycarbonate
Bracket Material: CRS Black Powder Coated
VMRS: 034-001-098

Trilliant®

PART #	DESCRIPTION	BEAM	CONNECTION	VOLTAGE
63N31	Trilliant Bi-Voltage	Flood	Blunt Cut	10-30V
63N41	Trilliant Bi-Voltage	Wide Flood	Blunt Cut	10-30V

E90 LED HALOGEN REPLACEMENT



LED WORK LIGHTS

- Value-priced LED technology
- Compact housing with a reduced depth of only 3.5 cm/1.38"
- Robust materials enhance endurance in tough environmental conditions
- 20 times longer life expectancy than standard halogen bulbs
- Water- and dust-proof in accordance with IP69K
- Premium-level EMC requirements (CISPR 25 class 5); won't interfere with radio signals

Material: Polycarbonate, Aluminum
Amperage: 0.7A @ 24 VDC, 1.4A @ 12 VDC
Connection: Hardwired
Regulations: ECE R10, R23, CE, ISO 7637-2 / ISO 16750-2 without testpuls 5 (load dump), ISO 10605, ISO 11452 Section 2 and 4 (CISPR 25 Class 5), ISO 20653

PART #	DESCRIPTION	BEAM	LUMENS	VOLTAGE
64U21-3	e90 LED Work Light	Far Flood	1,000 lm	12V
64U31-3	e90 LED Work Light	Far Flood	1,000 lm	24V
64U41-3	e90 LED Work Light	Near Flood	1,000 lm	12V
64U51-3	e90 LED Work Light	Near Flood	1,000 lm	24V



Grote Industries is revolutionizing safety and efficiency with our innovative 4SEE Smart Trailer System – a robust, easy-to-install telematics system designed to optimize every facet of your operations.



FOR COMPLETE TECHNICAL SPECS, VISIT OUR WEBSITE

SMART NOSE BOX



USER INTERFACE

DIGITAL HARNESS



SURFACE MOUNT, WITH MOTION SENSOR

S100 LED WHITELIGHT™ DOME LIGHT

- Sleek, low-profile design less than 15.0mm in height
- Moisture-proof construction allows for a wide variety of uses
- Surface mount allows for quick and easy installation
- ECE R10, Dir. 72/ 245/ EEC, Amended by 2006/ 28/ EC

61331 S100 LED WhiteLight™ Surface Mount Dome Light w/Motion Sensor, White

Lens Color: Clear
Material: Polycarbonate
Voltage: 9-32V
VMRS: 034-004-452



18 INCH DOME LIGHTS

- Motion sensor technology eliminates switches (certain models)
- Plastic housing with molded lens

PART#	DESCRIPTION	LUMENS	# OF LEDs	VOLTAGE	MOTION SENSOR
61P11	18" Dome Lamp	1000	10	12V	No
61P21	18" Dome Lamp	1500	18	12V	No
61P31	18" Dome Lamp w/MS	1000	10	12V	Yes
61P41	18" Dome Lamp w/MS	1000	6	12V	Yes
61P51	18" Dome Lamp w/MS	1500	18	12V	Yes
61P61	18" Dome w/MS & SYNC	1000	6	12V	Yes
61P71	18" Dome Lamp 24V	1000	16	24V	No
61P81	18" Dome Bi-Volt w/MS	1000	6	12V/24V	Yes
61P91	18" Dome Lamp w/dim function	1500	18	12V	No

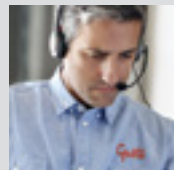

PREMIUM SERVICE

In a world of automated phone systems and outsourced customer service, it's rare to contact **REAL PEOPLE** with **REAL EXPERIENCE** providing **REAL SOLUTIONS**. That is exactly what you get from Grote's team of expert Sales and Customer Solutions personnel.



KNOWLEDGEABLE CUSTOMER SOLUTIONS TEAM

Our dedicated personnel are here to handle all of your questions related to ordering and inventory availability. You have questions, we are here to help!



REAL-TIME INVENTORY WITH G24/7™

Grote's G24/7™ gives you the capability to check inventory, place orders, and track order status. Available when you need, as you need, because making it easier for you to do business with us matters.



90MM LED HEADLAMPS



- 90mm diameter lens
- 9V–32V multi-volt design
- Cast-aluminum housing with sealed integrated connector
- Compact lamp profile fits most existing applications
- Hard-coated, high-impact polycarbonate lens
- Rated IP69K for maximum protection against dust and moisture intrusion
- Mounting system with included adjustment rods designed to replace standard 90mm halogen headlamps

Material: Polycarbonate, Powder-coated Aluminum
Mounting Type: 2- and 4-point rigid, 3-point using adjustment hardware
Operating Temperature: -40°F to +185°F (-40°C to +85°C)
Regulations: FMVSS 108 LB1V, ECE R149 Sym. (R113)



PART #	DESCRIPTION	BEAM PATTERN	CONNECTOR	CURRENT DRAW	LUMENS
84591	90mm LED Headlamp	Low	Integrated 2-pin DT	0.55A @ 28V, 1.13A @ 13.8V	830
84591-3	90mm LED Headlamp, bulk pack	Low	Integrated 2-pin DT	0.55A @ 28V, 1.13A @ 13.8V	830
84581	90mm LED Headlamp	High	Integrated 2-pin DT	0.66A @ 28V, 1.37A @ 13.8V	950
84581	90mm LED Headlamp	High	Integrated 2-pin DT	0.66A @ 28V, 1.37A @ 13.8V	950
64X01	90mm LED Headlamp	Combo High / Low	Integrated 4-pin DT	LB: 1.6A @ 14V, HB: 3.2A @ 14V	1,300/650
64X11	90mm LED Headlamp, ECE Symmetrical	Combo High / Low	Integrated 4-pin DT	LB: 1.6A @ 14V, HB: 3.2A @ 14V	1,300/650
64X21	90mm LED Headlamp, FMVSS 108 (SAE)	Combo High / Low	Integrated 4-pin DT	LB: 1.6A @ 14V, HB: 3.2A @ 14V	1,300/650

LED OFF-ROAD LIGHT BARS

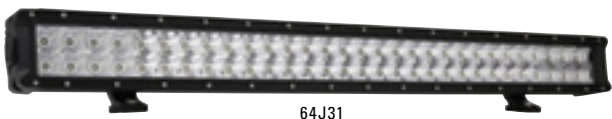
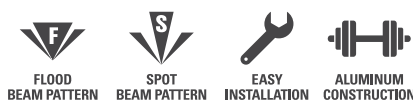

Work or play, rain or shine... Grote's LED Off-Road Light Bars will give you all the visibility you need for any occasion.

- Newly re-engineered to produce 50% more light, Grote's lights bars now feature a new combination flood/spot pattern
- Grote light bars are easier on vehicle electrical systems because they run cooler and use less power than halogen or HID lamps of the same output
- Enjoy multiple mounting options with the included pedestal or side brackets
- The bar lamps are built to withstand extreme heat or cold
- Available in 10", 20", and 30" lengths. Outfit your vehicle with great looking light bars that pack a punch

Housing Material: Anodized Extruded Aluminum
Lens Material: Polycarbonate
Regulations: J2139 S4.1/5.1, J2139 S4.4/5.4, IP67 IP69K
VMRS: 034-006-031

Harness: *If using harness with voltages over 14V, use relay 84-1093

PART #	DESCRIPTION	BEAM	CONNECTION	LUMENS	VOLTAGE	AMPERAGE
64J11	10" Light Bar, Combination Flood/Spot	Combo Flood/Spot	Deutsch®	5,400 lm	12/24V	3.2A at 12V
64J21	20" Light Bar, Combination Flood/Spot	Combo Flood/Spot	Deutsch®	10,800 lm	12/24V	6.6A at 12V
64J31	30" Light Bar, Combination Flood/Spot	Combo Flood/Spot	Deutsch®	16,200 lm	12/24V	10A at 12V
67790	Light Bar Replacement Harness*					

7" LED SEALED BEAM HEADLIGHT



- Replace your existing lights with the durable, long-lasting LED lights that Grote is famous for
- Improves the driving experience by decreasing eye fatigue and providing better detail, thus decreasing chances for accidents
- Headlight uses a hard-coated, UV-protected, high-impact polycarbonate lens that resists cracking and yellowing

63101-5 7" LED Sealed Beam Headlight

Housing Material: Polycarbonate
Lens Material: Polycarbonate
Bulb: Par 56
Connector: H4
Voltage: 10-32V
Amperage: 0.83A-1.66A @ 12V
Regulations: FMVSS 108
VMRS: 034-001-151

LED FOG LAMP ADAPTERS AND HARNESSES

- DOT, SAE J583 & FMCSA 393.25(b) approved LED Fog Lamps can be used on commercial vehicles or private vehicles
- Three wiring options, hard wire (pigtail included), basic harness system (sold separately) or deluxe harness system to use vehicle electronics (sold separately)
- 68660 Basic Harness comes with an On/Off switch for installation of your SAE-compliant auxiliary fog lights. This harness is designed to control the auxiliary lights with an on/off switch
- Fits 64H51-5
- Harness Voltage/Amperage: 9-16 VDC, Max Load 10A

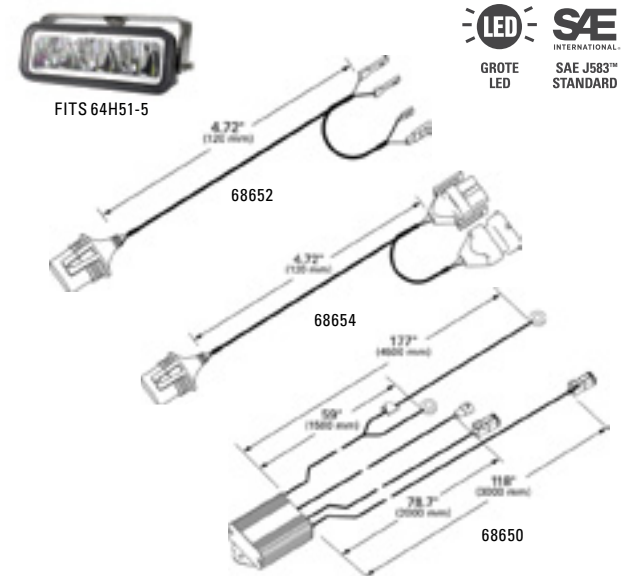

PART #	DESCRIPTION	CONNECTION	WIRE (L)
68655	LED Fog Lamp Headlight Adapter	9007 & 9005	4.5"
68652	LED Fog Lamp Headlight Adapter	H1 & 9005	4.5"
68653	LED Fog Lamp Headlight Adapter	H13 & 9005	4.5"
68654	LED Fog Lamp Headlight Adapter	H11 & 9005	4.5"
68656	LED Fog Lamp Headlight Adapter	9005	4.5"
68651	LED Fog Lamp Headlight Adapter	H4 & 9005	4.5"
68660	Basic LED Fog Lamp Harness	Deutsch®	6.5'–9.5'
68650	Deluxe LED Fog Lamp Harness	Deutsch®	6.5'–9.5'

FORWARD LIGHTING ADAPTERS AND HARNESSES

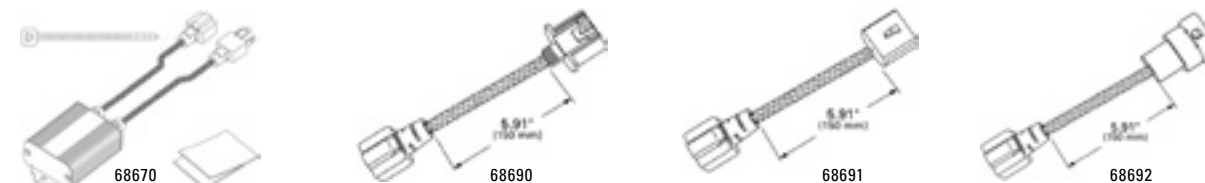

PART #	DESCRIPTION	CONNECTION	WIRE (L)	AMPERAGE	VOLTAGE	WATTAGE
68670	Anti-flicker Harness	H4M Male/Female	11"	0.5A @ 13.5V	DC 9-16V	6W
68690	H4-H13 Adapter	H4F, H13	5.9"	5A @ 12V	DC 9-16V	60W
68691	H4-9007 Adapter	H4, 9007	5.9"	5A @ 12V	DC 9-16V	60W
68692	H4-9005 Adapter	H4, 9005	5.9"	5A @ 12V	DC 9-16V	60W

GROTE'S LED AUXILIARY STROBE & STOP LAMPS

FIGHT THE DANGERS OF DISTRACTED DRIVING

Grote's Auxiliary Strobe & Stop Lamp is a groundbreaking warning light that brings greater visibility to trailers during braking. The Auxiliary Strobe & Stop Lamp is easily wired into an existing brake light circuit and emits a sequence of five amber flashes in four seconds, followed by a solid red burn when the vehicle's brakes are engaged. Reducing rear-end collisions and increasing operator safety with this simple, effective warning light means less equipment and freight damage, less downtime, and fewer delayed shipments.



FOR COMPLETE TECHNICAL SPECS, VISIT OUR WEBSITE

LED AUXILIARY STROBE & STOP LAMPS



FEATURES & BENEFITS

- Available in two mounting styles to fit a wide array of vehicles
- 0.2" mounting hole with several wiring options to fit all harness systems
- Five amber flashes in four seconds, followed by a solid red burn
- Studies show that flashing brake lights can reduce rear-end accidents by more than 33%

Material: Polycarbonate/Aluminum
Lens Color: Clear
78462 Voltage Amp: 12V / 0.2A-0.4A
79212 Voltage Amp: 12V / 0.13A
Operating Temperature: -40°F to +131°F (-40°C to +55°C)
Warranty: 5 Years
VMRS: 034-001-021

PART #	MOUNTING	CLASSIFICATION	COLOR
78462	Surface Mount	SAE J845 Class II	Amber/Red
78462-3	Surface Mount, Bulk Pack	SAE J845 Class II	Amber/Red
79212	Grommet/Bracket	SAE J845 Class II	Amber/Red
79212-3	Grommet/Bracket, Bulk Pack	SAE J845 Class II	Amber/Red



TRAFFIC DIRECTOR / STICK ACCESSORIES



LOW-PROFILE LED REPLACEMENT MODULES

- Traffic Directors and Sticks are designed for easy front load installation of Replacement Modules. *Note: Cannot be used as a standalone work light, only works with Traffic Directors and Sticks*
- Designed for products 78200, 78210, 78270, 78370, 78380, 78410

Material: Polycarbonate/Aluminum
Lens Color: Clear
Voltage Amp: 12V / .05A
Operating Temperature: -22°F to +122°F (-30°C to +50°C)

PART #	DESCRIPTION	CLASSIFICATION	COLOR
98343	LED Replacement Module	SAE J595 Class I	Amber
98345	LED Replacement Module	SAE J595 Class I	Blue
98341	LED Replacement Module	SAE J595 Class I	White
98342	LED Replacement Module	SAE J595 Class I	Red
98344	LED Replacement Module	SAE J595 Class I	Green

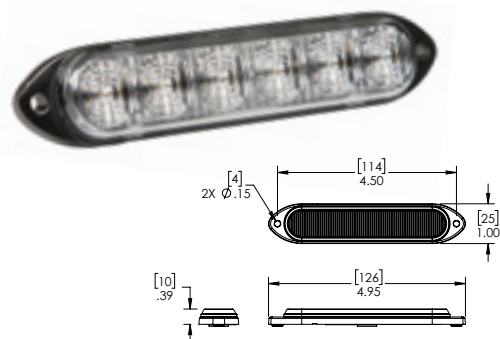

CLASS II

LED DIRECTIONAL WARNING LIGHT



- Horizontal surface mount; Ultra low profile; Single and split color models
- Polycarbonate construction coupled with a dependable gasket design ensures superb moisture and vibration resistance
- S-Link™ System* synchronizing capabilities with up to six other units allows for synchronization with other S-Link compatible products
- Versatile LED directional warning light can be synchronized with up to 8 interconnected modules and 25 different built-in flash patterns

78460 LED Directional Warning Light, Surface Mount, 6-Diode, Amber/White

Lens Color: Clear
Material: Polycarbonate/Aluminum
Mounting Type: Permanent
VMRS: 034-001-021



COMPACT LED BEACONS



- 79093: 12 different selectable flash patterns, plus steady-on
- 79183 & 79193: 26 different selectable flash patterns, including steady-on
- Compact design with super bright LED light output that conforms to SAE J845
- Durable, lightweight polycarbonate base featuring 3-hole flange, 1/2" pipe mount, or magnet mount options
- Auxiliary plug (with on/off and pattern select switch)
- Ideal for mirror-mount applications or where low-profile lamps are beneficial

Color: Amber
Material: Polycarbonate
VMRS: 034-006-056

PART #	DESCRIPTION	MOUNT	COLOR
79093	LED Compact Beacon, Class I, 12/24V	Permanent	Amber
79183	LED Compact Beacon, Class II, 12/24V	Permanent	Amber
79193	LED Compact Beacon, Class II, 12V	Magnetic	Amber
ACCESSORIES			
98513	7909 Amber Replacement Lens		Amber
93604	1/2" Mirror Mounting Bracket		
93604-KIT	1/2" Mirror Mounting Bracket, Wiring & Connectors		



HINVII: SAFETY WITH INTELLIGENT ILLUMINATION



- Get the most out of high-visibility clothing and gear, enhancing worksite visibility and safety
- Perfect for applications where high-visibility clothing is used: Police, Fire, EMS, Utility, Refuse Collection, and more
- Can be used with or without an external flasher
- An ultra-thin profile bezel mount easily mounts to nearly any solid, flat surface
- 79266 features the S-Link™ 2.0 System for synchronizing with other Grote S-link units

PART #	DESCRIPTION
79276	6 Diode HINVII Led Directional
79276-3	6 Diode HINVII Led Directional, Bulk Pack
79266	Dual Function, 6 Diode Amber / 4 Diode HINVII
79266-3	Dual Function, 6 Diode Amber / 4 Diode HINVII, Bulk Pack

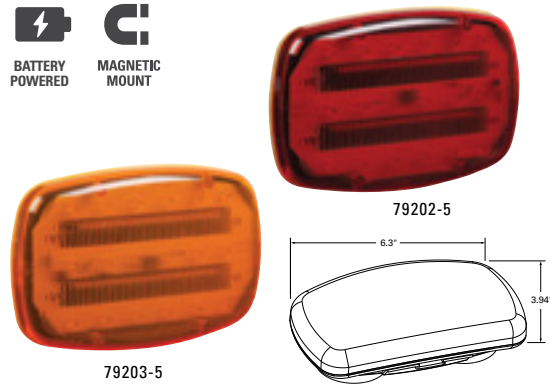
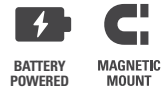

LED MAGNETIC WARNING LIGHTS
BATTERY OPERATED

- Mag mount attaches securely to back of vehicle or optional galvanized bracket
- Flashing or steady-on operation
- Requires 4 x AA batteries (not included)
- Features two heavy-duty magnets

Material: Polycarbonate
VMRS: 034-001-021

WARNING: Magnetic mounted lamps are not recommended for use on moving vehicles, nor are they intended as a permanent mounted warning lamp.

PART #	DESCRIPTION	COLOR
79202-5	LED Magnetic Warning Lamp	Red
79203-5	LED Magnetic Warning Lamp	Amber
ACCESSORY		
42380	Galvanized Bracket	

360° PORTABLE LED WARNING LIGHT, AMBER
BATTERY OPERATED

- 24 ultra-bright LEDs help conserve battery life
- 300-400 hours of operation on two D batteries (not included)
- 60 triple flashes per minute
- Photocell adjusts intensity for low light situation
- Strong magnetic base holds lamp in place on a metal surface

77913-5 360° Portable Battery Operated LED Warning Light (NEW RETAIL PACK)

Lens Color: Amber
Material: Polycarbonate, Nylon
Mounting Type: Magnetic
VMRS: 034-001-021

LED TOW BAR ACCESSORIES
BATTERY OPERATED

- Fits 79153, 79143, 79133
- Multiple mounting options for our line of large light bars
- See our application guide to select the correct bracket for your vehicle
- 98532 is required when using a "Flex Gutter Kit"

PART #	DESCRIPTION	MATERIAL	MOUNTING
98542	Tow Bar Bracket for Spotlight	Steel	Bolt
98532	Optional Roof Mount Bracket	Glass-Filled Nylon	Bolt
42400	4.6" Flex Gutter Kit	Stainless Steel	Bolt
42410	6.2" Flex Gutter Kit	Stainless Steel	Bolt
42420	8.4" Flex Gutter Kit	Stainless Steel	Bolt

TRIANGLE WARNING KIT / ECONOMY KIT
BATTERY OPERATED

- Kit consists of three triangle devices in carrying case
- Reflective up to ½ mile
- Weatherproof and impact-resistant; Weighted for stability

71432 Triangle Warning Kit / Economy Kit

Color: Red
Standards: J774C, J575
Regulations: FMVSS 125
Material: PMMA/ABS
Weight: 3.21 lbs
VMRS: 053-004-005

MIGHTY MINI STROBE LIGHT

- 80 flashes per minute; 1.5 joules, wide voltage operating range
- Field-replaceable lens and flash tube
- Features reverse polarity and voltage spike protection

77103 Mighty Mini Strobe Light, Amber

Color: Amber
Material: ABS, Polycarbonate
Mounting Type: Permanent
VMRS: 034-001-063

BACKUP ALARM

- Mounts in standard 4" grommet (grommet not included)
- Epoxy-sealed to protect against dust, moisture and vibration

73420 4" Grommet-Mounted Backup Alarm, 102dB, Dual Tone

Voltage: 12 to 24 VDC
Amp Draw: 0.7 amps
Material: Glass-Filled Nylon
VMRS: 054-002-001

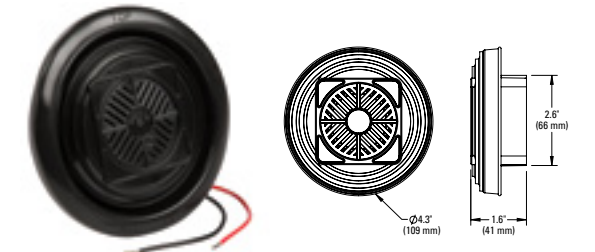
BEACON REPLACEMENT LENSES

Material: Polycarbonate

PART #	DESCRIPTION	HEIGHT	DIA.	COLOR
98174	Tall Replacement Lens, Twist-on	6.0"	5.5"	Green
98224	Short Replacement Lens, Twist-on	4.1"	5.5"	Green

FORD F-SERIES MOUNTING BRACKETS

- Fits products 2019 & UP F150, F250, F350

Color: Black
Material: Powder-Coated Aluminum
Width: 17.75"
Application: Ford F-Series

PART #	DESCRIPTION
42390	Ford F-Series Mounting Bracket for trucks with Halogen Brake Lamps
42391	Ford F-Series Mounting Bracket for trucks with LED Brake Lamps
42392	Steel Mounting Plate for Magnet Mounted Lamps (fits 42390, 42391)

LED TRAFFIC DIRECTORS/CONTROLLERS

- 14 brightness settings
- Includes replaceable velvet finish Lexan™ labels to customize your controller buttons

Mounting Type: Universal U Bracket (Aluminum)
Material: Polycarbonate
Voltage: 12 VDC
VMRS: 034-001-021

PART #	DESCRIPTION
98524	Advanced Programmable, 8-button, operates up to 8 lights/devices
98523	Programmable, 5-button, operates up to 4 lights/devices





SUPERNOVA® THIN-LINE LED

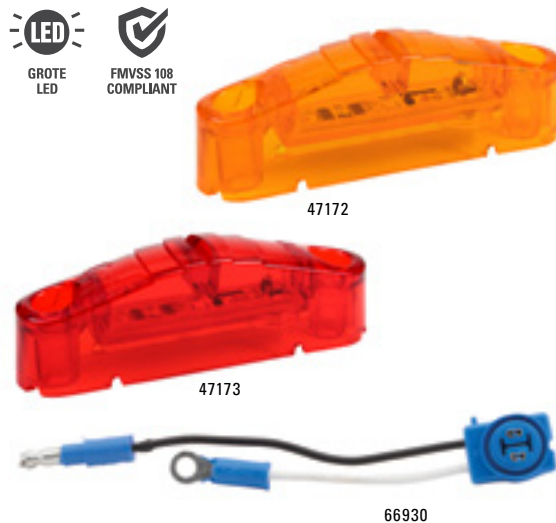

LED CLEARANCE MARKER LIGHTS

- Encapsulant potting for total circuit-board protection
- Sealed marker lamp
- Thin-Line design fits narrow rails and channels
- Uses UBS double-seal pigtail for maximum protection against corrosion

Material: Polycarbonate
Amperage: 0.7A
VMRS: 034-004-021

PART #	DESCRIPTION	LENS COLOR
47172	SuperNova Thin-Line LED	Red
47172-3	SuperNova Thin-Line LED, Bulk Pack	Red
47173	SuperNova Thin-Line LED	Amber
47173-3	SuperNova Thin-Line LED, Bulk Pack	Amber
65602	SuperNova Thin-Line LED and Pigtail 66930	Red
65603	SuperNova Thin-Line LED and Pigtail 66930	Amber

MICRONOVA® DOT



LED CLEARANCE MARKER LIGHTS

- Available in PC and P2 versions with .180 bullet or Deutsch® connectors
- No fasteners required
- Sleek aerodynamic styling extends less than 3/8" from mounted surface

Materials: Acrylic Lens, PVC Grommet
VMRS: 034-004-253

PART #	DESCRIPTION
49332	MicroNova Dot LED Clearance Marker Light, Red, w/Grommet
49333	MicroNova Dot LED Clearance Marker Light, Amber, w/Grommet, P2/PC

MICRONOVA® DOT MOUNTING BRACKET



- 2 1/2" - 3" mounting hole spacing
- Allows MicroNova® DOT to mount directly to vehicle or snap-fit into compatible mounting brackets

94350 MicroNova® DOT Mounting Bracket, Gray

Material: Polycarbonate
VMRS: 034-004-036

TRY THE EZ-FIND SYSTEM TODAY.

SIMPLY SCAN WITH YOUR CAMERA ON A CONNECTED MOBILE DEVICE TO ACCESS...

- Product Photo, Technical Specs, Videos
- Line Art with Dimensions
- Installation Instructions
- Related Information and Documents



LED WIRELESS MAGNETIC TOWING KIT

Equip your RV, marine, or light-duty trailer with one of Grote's magnetic towing kits for maximum visibility and safety. These handy lighting kits include installation components and feature strong mounting magnets to ensure that each lamp stays exactly where you need it.

- Each light uses 4 AA batteries
- Easy-to-stow case includes two lights, transmitter, and 4-way flat wire plug
- Heavy-duty magnetic base

99131-5 LED Wireless Magnetic Towing Kit, Red

Materials: Polycarbonate Lens, ABS Housing
Voltage: 6V battery, 12V transmitter
Connection: 4-pin flat-wire
Ingress Protection: Lamp IP34, Transmitter IP56
VMRS: 034-002-013



WITH AUXILIARY BRAKE LIGHT

- Connects and receives the signal using a 4 flat-wire receptacle
- Fits all 2" receiver hitches
- Foam gasket ensures a snug fit
- Protects the trailer hitch while not in use

54901-5 2" LED Trailer Hitch Cover with Auxiliary Brake Light, Red

Materials: ABS Housing, Polycarbonate Lens
Voltage: 12V
Amperage: 0.0833
Connection: 4 Flat-Wire
Ingress Protection: IP23
VMRS: 034-004-002

2" LED TRAILER HITCH COVER



LED TRAILER KIT LIGHTS

- Kit includes lamps, license plate bracket, and complete wiring/installation kit
- Ideal for boat trailers, utility trailers, and other light-duty, recreational trailers
- Impact-resistant housing
- All-weather protection

Voltage: 12V
Standards: FMVSS-108
 SAE J594f: 46673
 SAE J592E: 46673, 49010, 49020
Material: Acrylic Lens / ABS / Polycarbonate



PART #	DESCRIPTION	TERMINATION	COLOR
65080-5	Submersible Trailer Rectangular LED Kit, Under 80"	Hard Wired	Red
65270-5	Square Trailer LED Stop/Tail/Turn Lamp Kit, Over 80"	Hard Wired	Red
46673	Surface Mount Clearance/Marker	Hard Wired	Amber
49010	LED Clearance Lamp Road Side	Hard Wired	Red/Amber
49020	LED Clearance Lamp Curb Side	Hard Wired	Red/Amber

CENTER MOUNT

LED STOP TAIL TURN LIGHT



- Can be mounted in vertical, horizontal or 45° angle
- Impact-resistant housing is sealed for moisture protection
- Stop, tail, turn system utilizes one lamp

53582-5 15" Center Mount Stop Light, Red, Retail

4" AND 6" IN WITH DEICING

LED STOP TAIL TURN LIGHTS



- Automatically begins to transfer heat once temperature falls below 40° F
- Decrease downtime by reducing the need for drivers to scrape lights
- Keep lights free from snow and ice during trips
- Stay seen, safe, and legal on the road with unobstructed lights
- An advanced thermo regulator monitors lens temperature to prevent overheating and reduce power draw

Amperage Upper Limit: 2A
Connector: Hardshell

PART #	DESCRIPTION	VOLTAGE	AMPERAGE
55022	4" Round w/o Backup	14V	0.02A–0.244A @ 14V
55262	4" Round w/ Backup	14V	0.02A–0.352A @ 14V
54822	6" Oval w/o Backup	12V	0.006A–0.116A @ 12V
54812	6" Oval w/ Backup	12V	0.006A–0.155A @ 12V

SUPERNOVA® OVAL

LED STOP TAIL TURN LIGHTS



54802



54792

- Advanced pin-connection system uses tin-plated, solid-brass terminals
- Encapsulant potting for total circuit-board protection
- Male pin termination for maximum moisture and corrosion protection
- Meets specifications for vertical and horizontal mounting

Material: ABS, Acrylic
Amperage: .06A (T), .48A (I,S)
VMRS: 034-002-059

PART #	DESCRIPTION
54802	SuperNova® Oval, Grommet Mount, Hard Wired, Red w/ Clear Lens
54792	SuperNova® Oval, Grommet Mount, Hard Wired, Red w/ Red Lens

GROMMETS FOR 6" OVAL LIGHTS



- Designed to Fit Panel Thickness 9/64" to 5/8"
- Allows 53963 SuperNova® Oval Lamp to meet ASABE specifications
- Fits 2 1/2" x 6 19/25" oval mounting hole
- When using with panel thickness greater than 3/8", the hole size should be slightly larger to achieve reasonable assembly insertion force

92140 6" Oval, Open Grommet
92140-3 6" Oval, Open Grommet, bulk pack

LED REPLACEMENT BULBS & ACCESSORIES



PART #	DESCRIPTION	BASE	PACK SIZE	VOLTAGE	COLOR
94751-4	Industry Standard #194, Wedge Base, Pair pack	Wedge	Pair	9-16V	○ White
94753-4	Industry Standard #194NA, Wedge Base, 12V, Pair pack	Wedge	Pair	9-16V	● Amber
94851-4	Industry Standard #3157, Wedge Base, Pair pack	Wedge	Pair	9-16V	○ White
94771-5	Industry Standard #211, Festoon Base	Festoon	1	9-16V	○ White
94811-4	Industry Standard #1157, Bayonet Base, Pair pack	Bayonet	Pair	9-16V	○ White
94791-4	Industry Standard #1156, Bayonet Base, Pair pack	Bayonet	Pair	9-16V	○ White
94853-4	Industry Standard #3157NA, Wedge Base, Pair pack	Wedge	Pair	9-16V	● Amber
94813-4	1157 Replacement Bulb	—	Pair	9-16V	● Amber
94913-4	T10 Replacement Bulb	—	Pair	9-16V	● Amber
94931-4	T15 Replacement Bulb	—	Pair	9-16V	○ White
94911-4	T10 Replacement Bulb	—	Pair	9-16V	○ White
94912-4	T10 Replacement Bulb	—	Pair	9-16V	● Red
94900-5	Accessory: 50W Load Equalizer (eliminates "bulb out" warning)				

ULTRA NOSE BOX®

- 39-pin connections eliminates overcrowding of wires
- 7 threaded post for ring terminal connection
- Hinged door keeps elements out, while providing easy access
- Insert-molded pins helps prevent accidental disconnects
- Replaceable 7-pin insert for easy maintenance
- Replacement cover for 87141



97831 Nose Box Front Cover, Solid Pin

FLOW-THRU HARNESS

- Flow-thru harness for attaching two Auxiliary Strobe & Stop Lamps to top rail of trailer
- 235 inches (165" to split – 70" end)



66450 Flow-Thru Harness – Two Standard Males Connectors, Four Standard Female Connectors

Wire Gauge: 14 GA

DUAL FUNCTION JUMPER HARNESS

- Slim-Line .180" Female Bullets, Slim-Line .180" Male Bullets

66242 9" Jumper Harness - 3 Standard Males to 2 Standard Females





GROTE INDUSTRIES, INC.

2600 LANIER DRIVE
MADISON, INDIANA 47250 USA
T 812-273-1296
800-628-0809
800-457-9540
F 812-265-8440
E safety@grote.com

GROTE MANUFACTURING LTD.

230 TRAVAIL ROAD
MARKHAM, ONTARIO L3S 3J1 CANADA
T 905-209-9744
800-268-5612
F 905-209-9757
800-267-9024
E customerserviceca@grote.com

GROTE COMERCIAL LATINOAMÉRICA, S.A. DE C.V

AVE. ROGELIO GONZÁLEZ CABALLERO 225
PARQUE INDUSTRIAL STIVA AEROPUERTO
APODACA, NUEVO LEÓN, MÉXICO
CÓDIGO POSTAL 66626
T +(52) 818262 4413
F +(52) 818262 4404
E mexico@grote.com

GROTE INDUSTRIES EUROPE GmbH

WILLIAM-GROTE-WEG 1
D-94327 BOGEN
GERMANY
T +49 9422 40331-0
E europe@grote.com

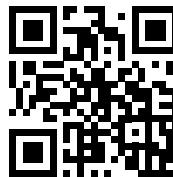
WWW.GROTE.COM**GROTE.COM**

If you're looking for the latest information about Grote products, be sure to check out our website, Grote.com. Instantly access our full product catalog, competitive interchanges, distributor locator, live helpdesk, and a wide range of Grote resources. The search function allows users to filter products by size, shape, voltage, content, and brand, among others. Help your customers find the parts they need, when they need them, with Grote.com.